

somfy®

Connectivity kit

Installation guide

EN

Welcome !

Start Connectivity kit
in a few steps

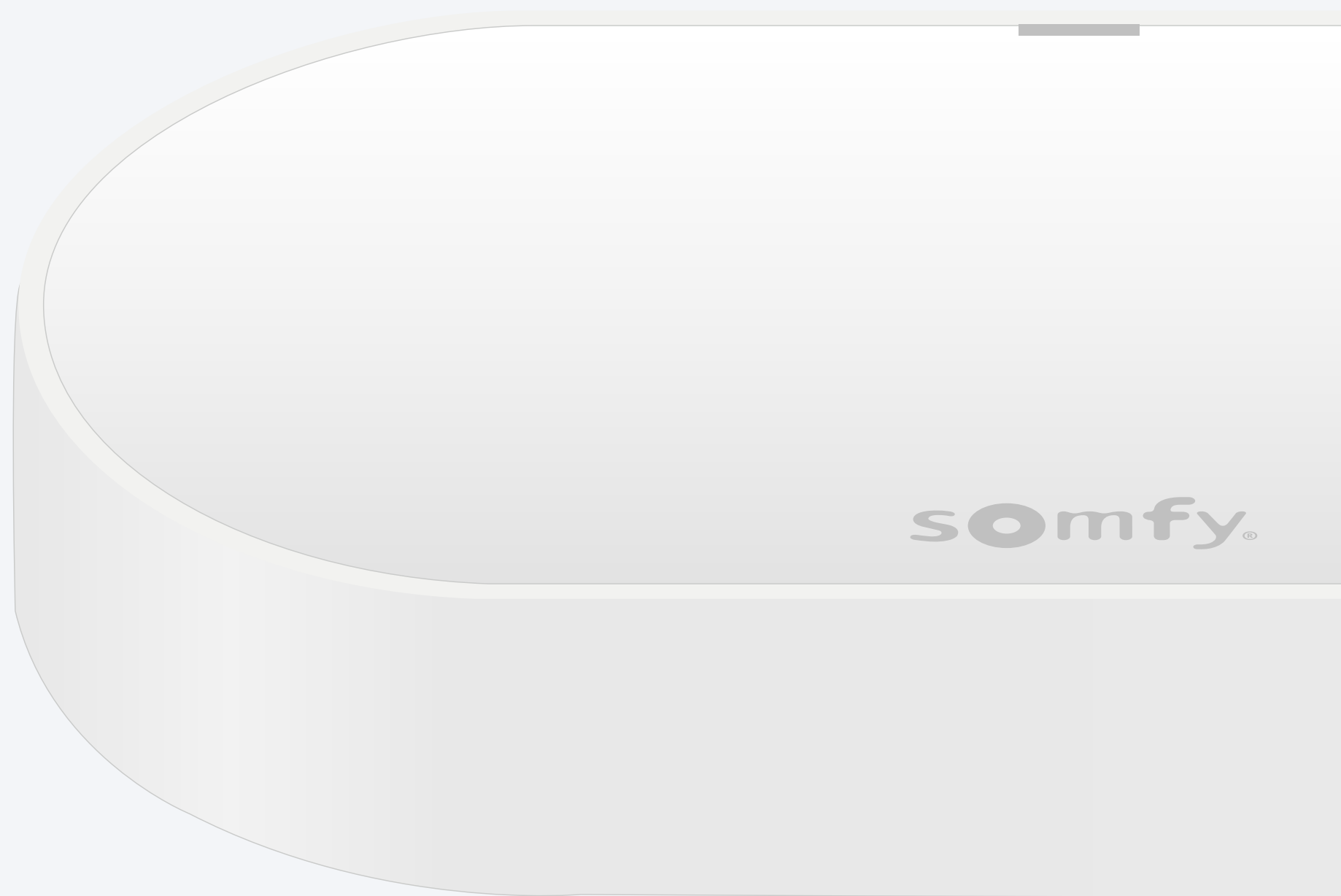

Pack content*

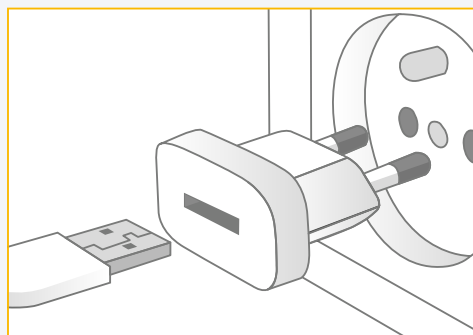
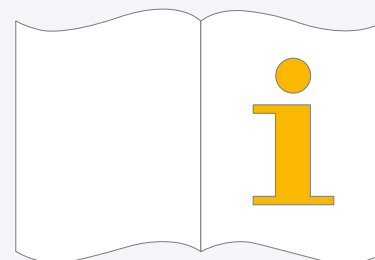
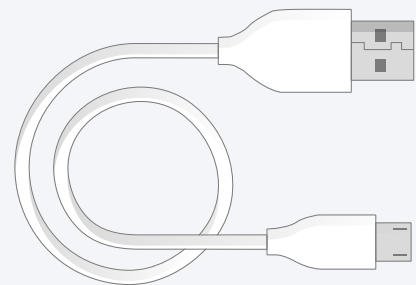
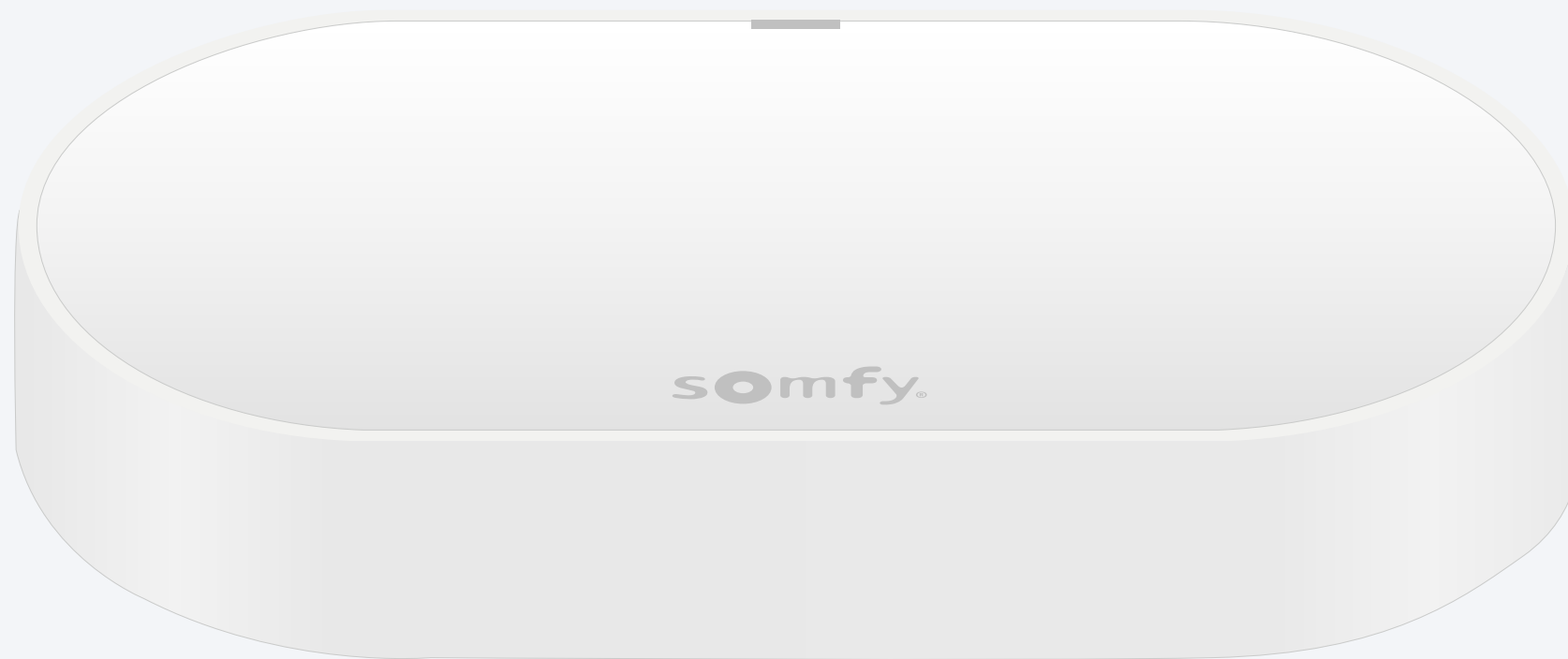

Add a USB adapter
Output: DC 5V 0.5A
Not included

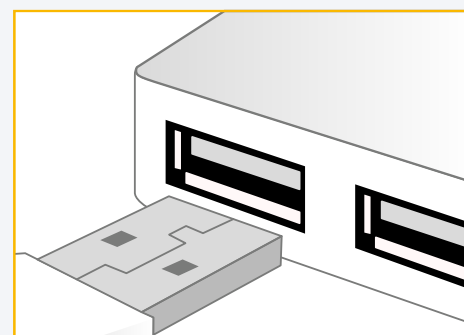

Or plug on a USB port
Always powered

Install TaHoma[®] app



Follow instructions

TaHoma[®] installed

1. Launch TaHoma[®] app

Start

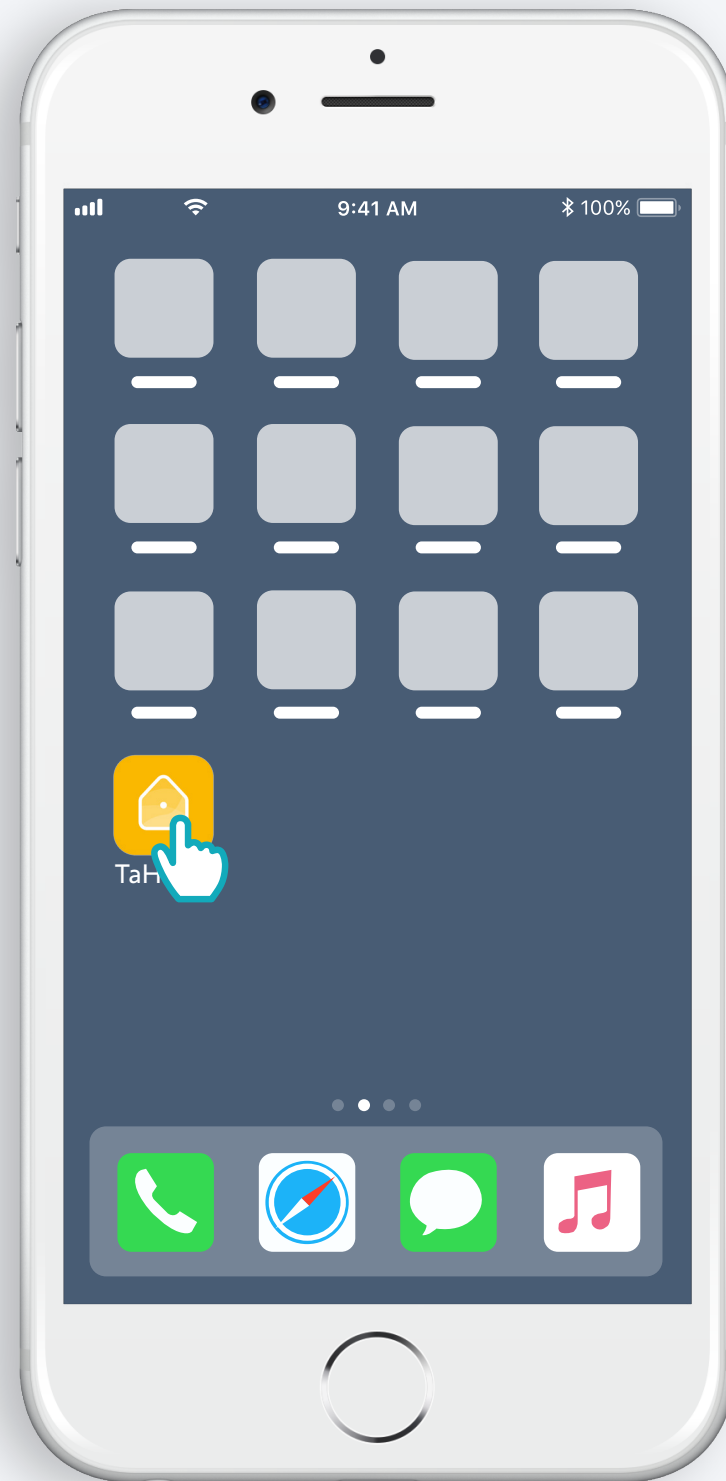

Open TaHoma[®] app

Start

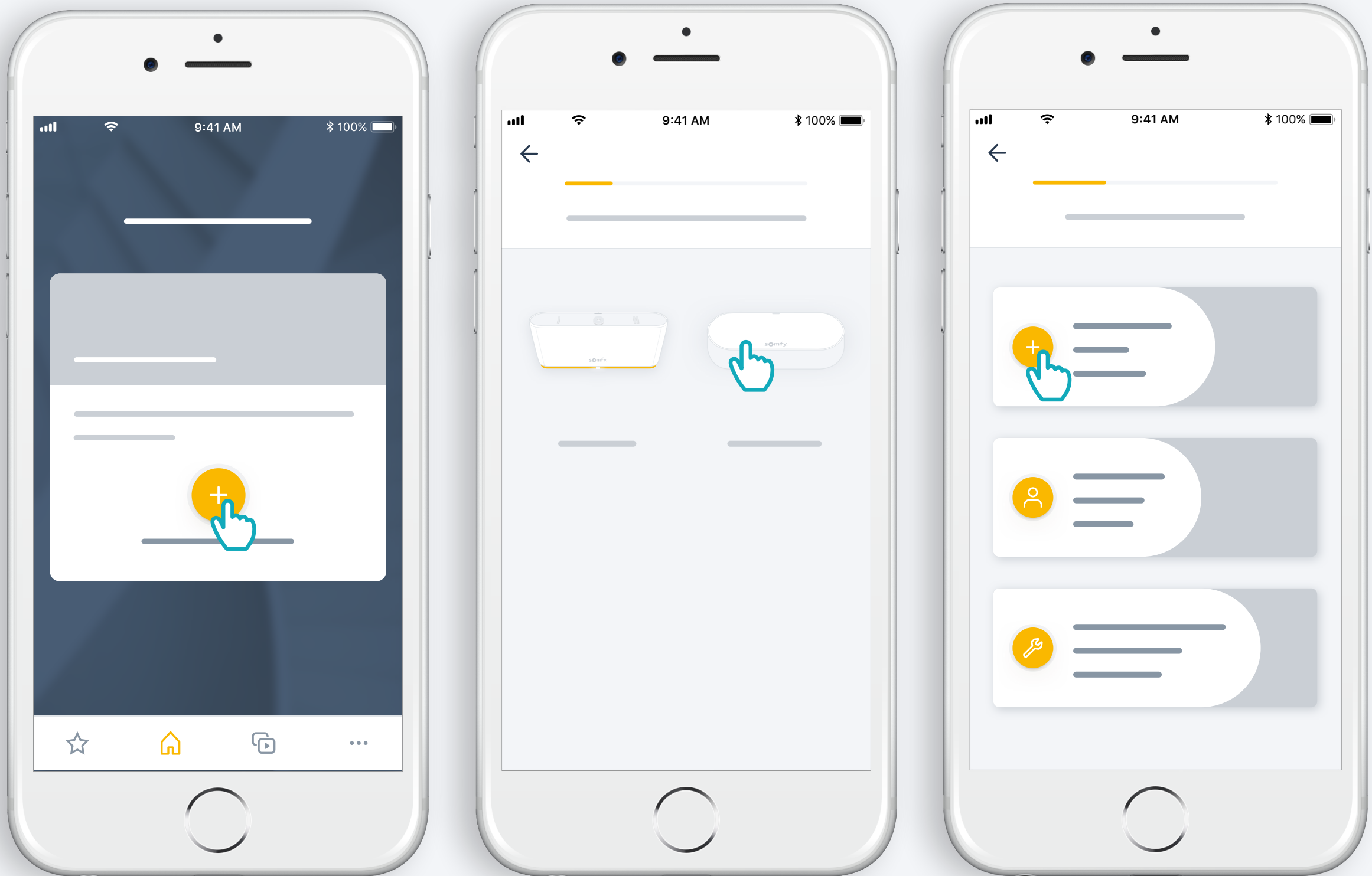

Start Connectivity kit installation

Plug power supply

Add a USB adapter
Output: DC 5V 0.5A
Not included

OR

Plug on a USB port
Always powered

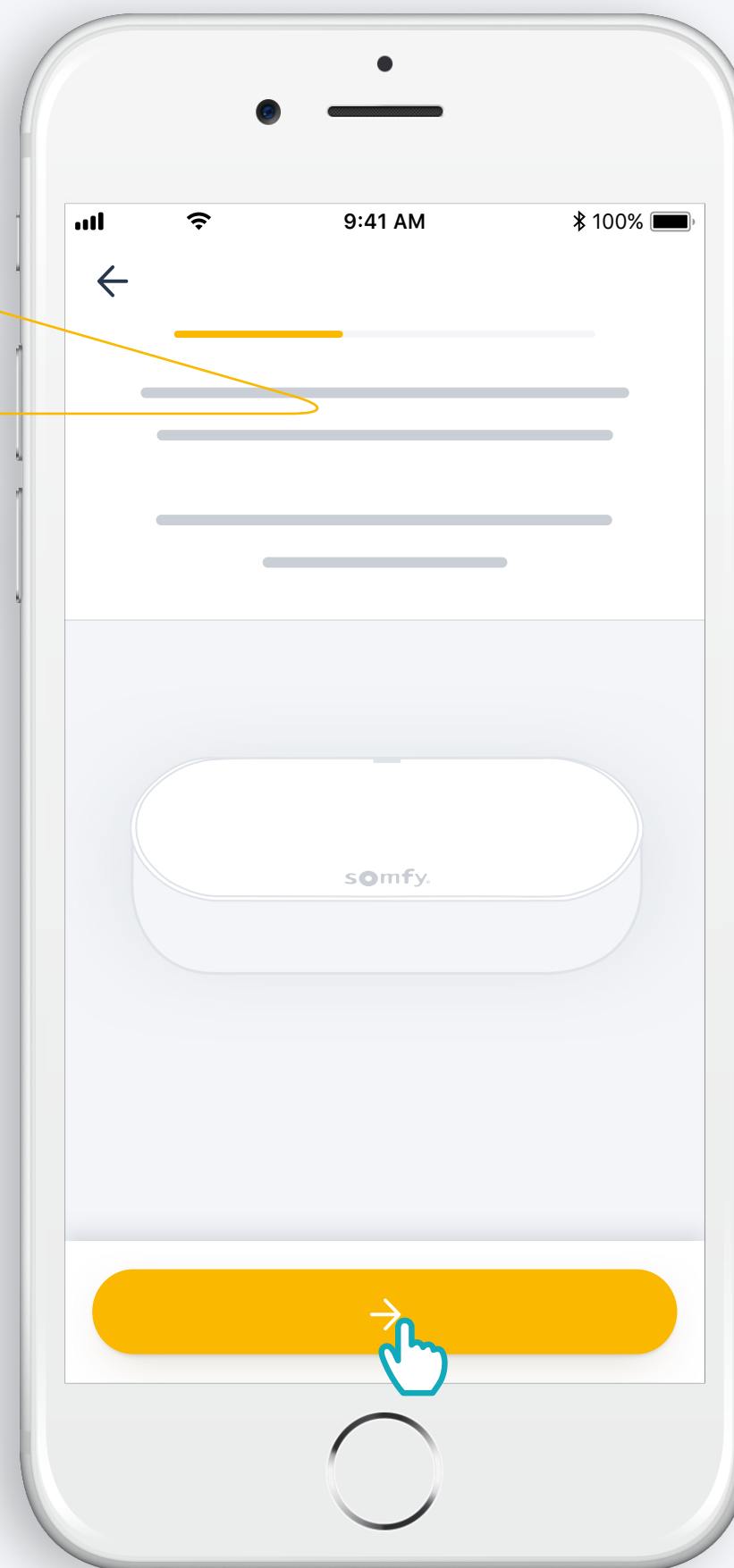
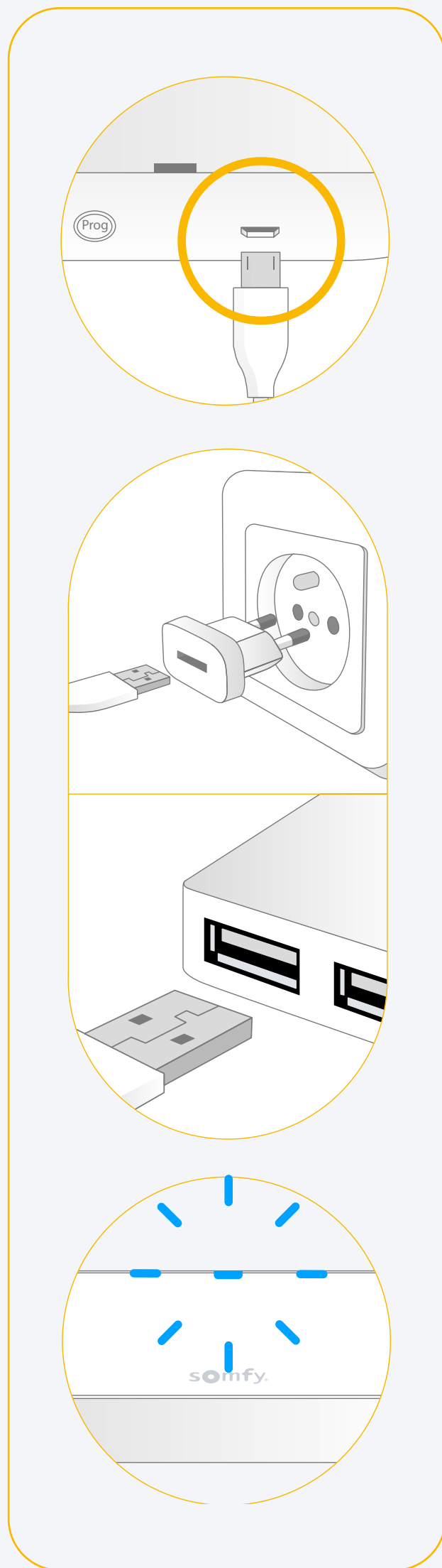

Connect to the internet

Your WiFi network must be in 2.4 GHz and secured with a password.

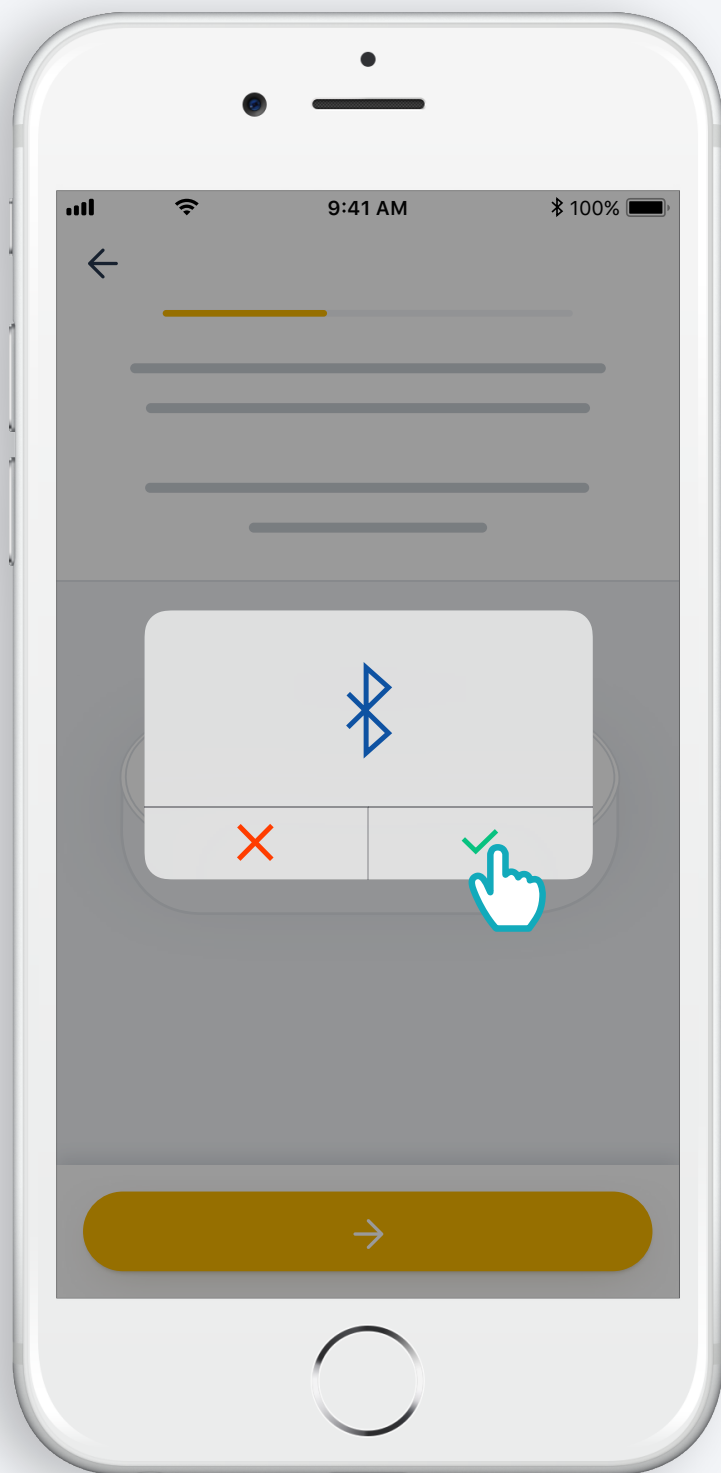

Accept Bluetooth

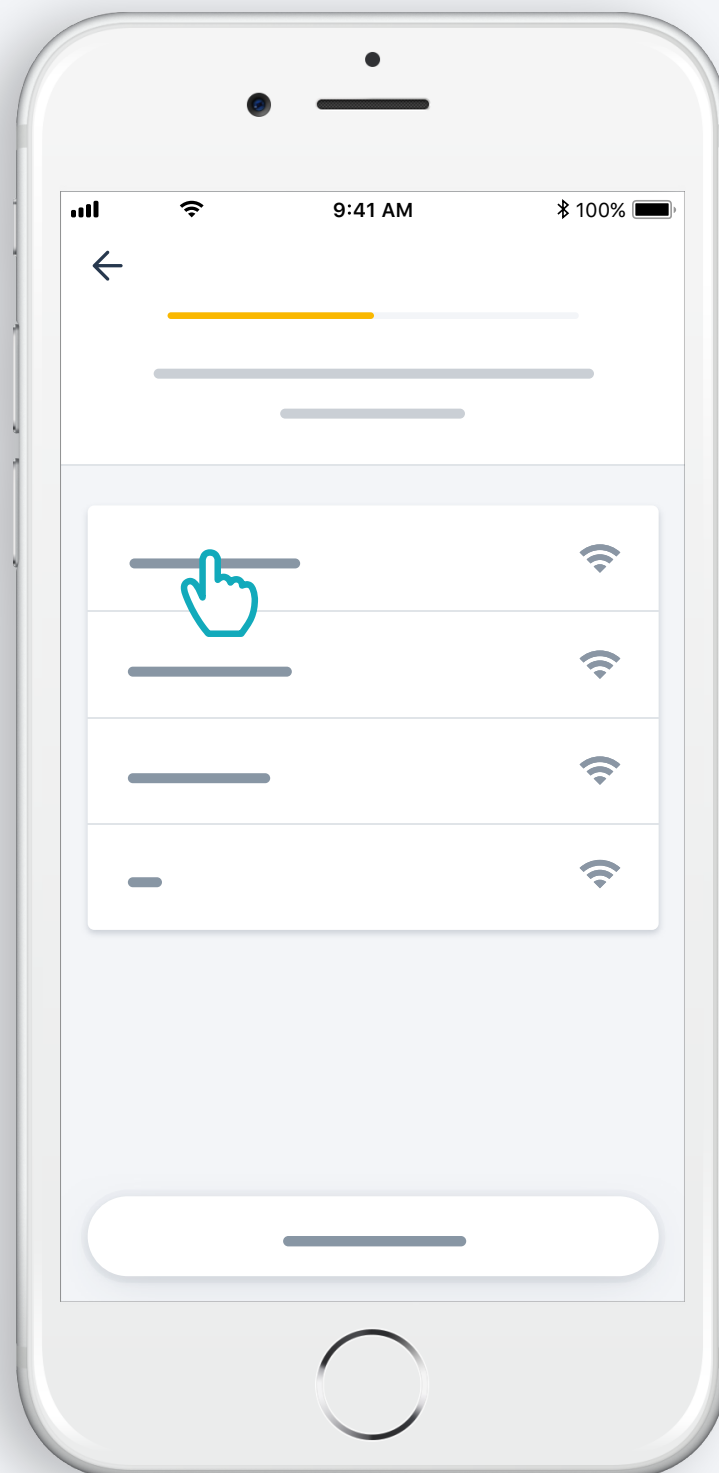

Select WiFi and enter password

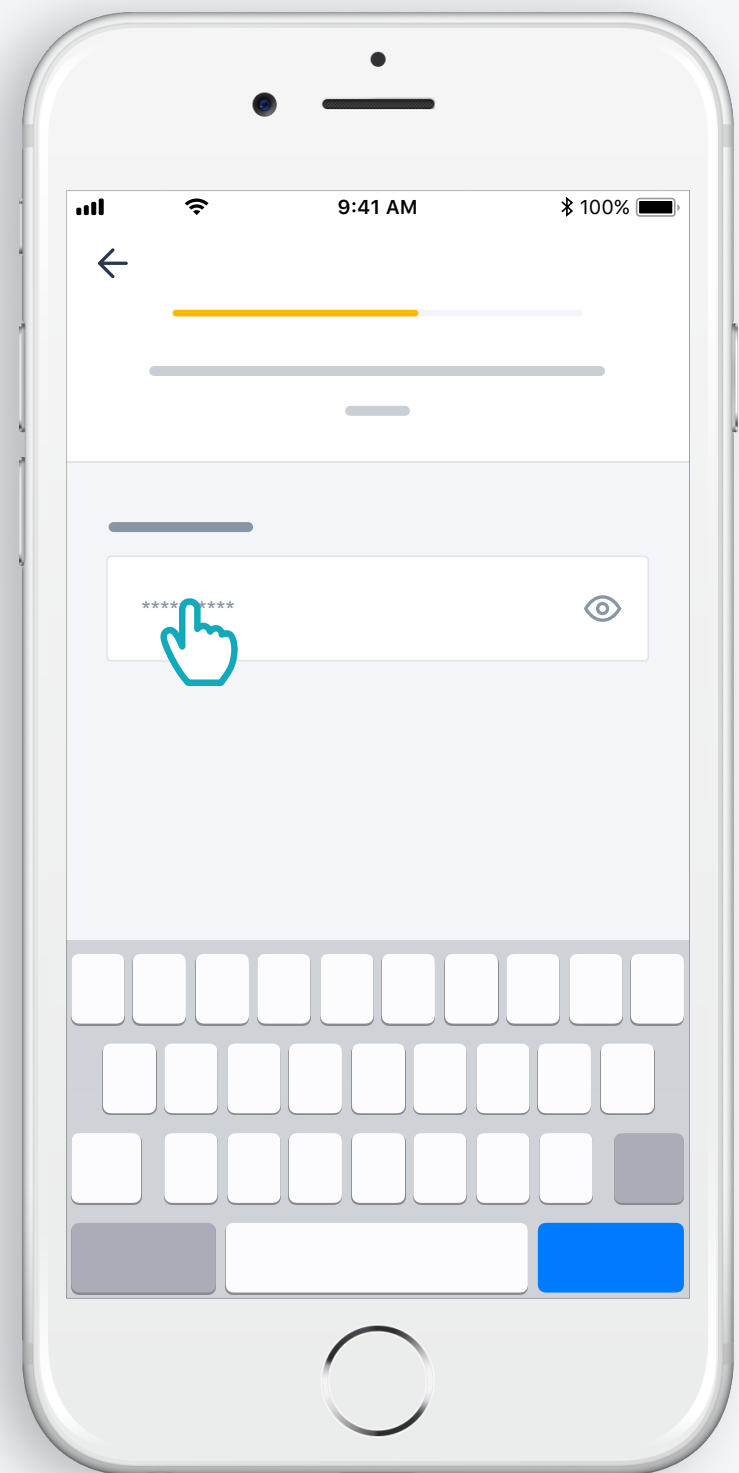

2. Create your TaHoma[®] account
or Log in

Create your TaHoma[®] account or Log in

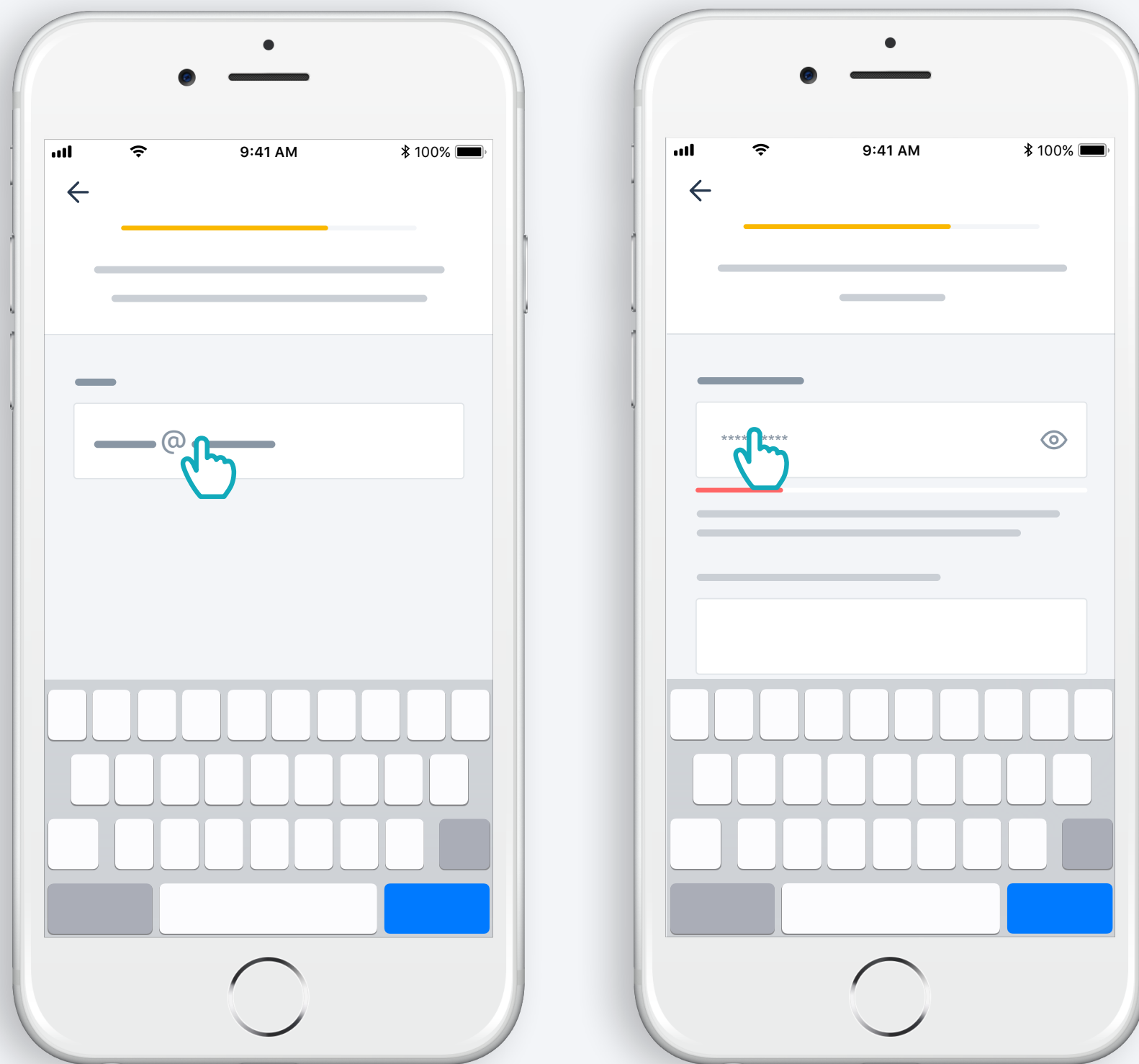

Enter your email address and password

Follow the instructions

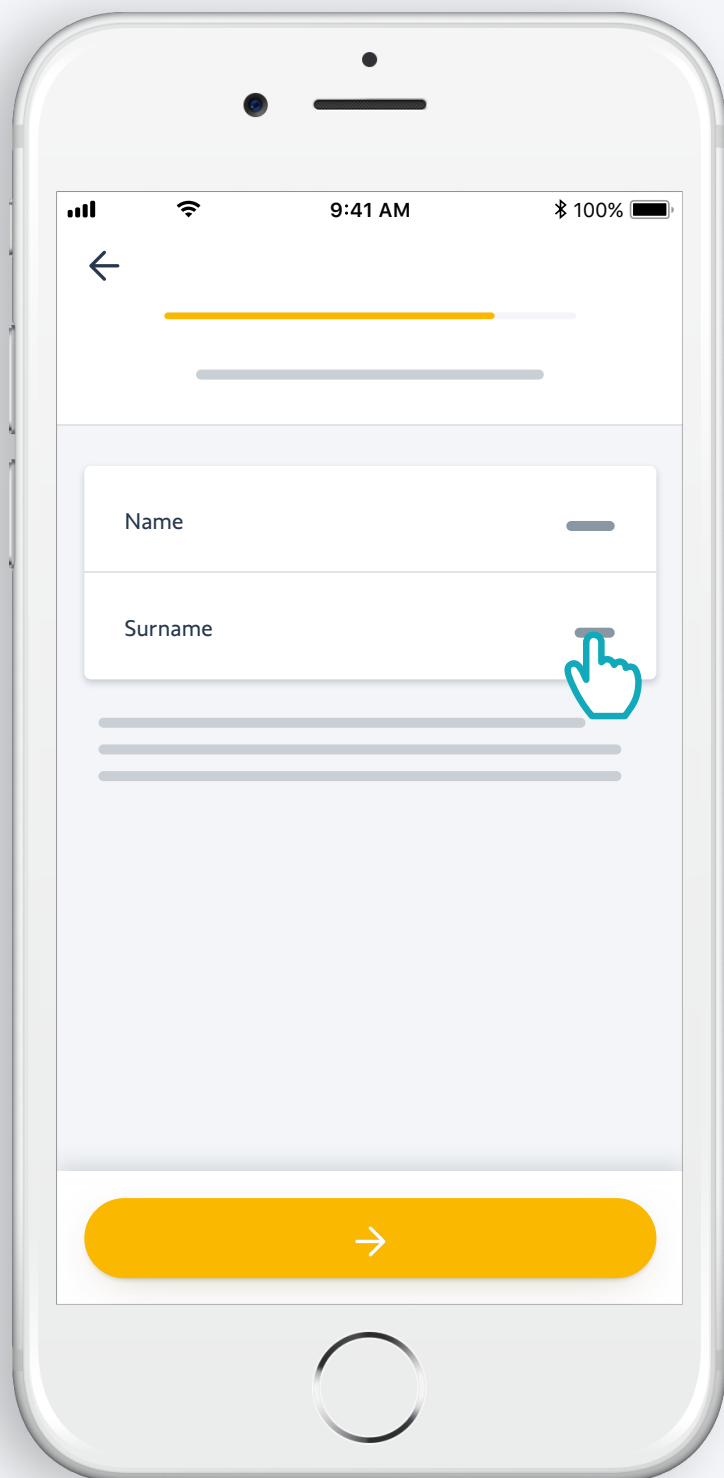

Enter your name
and your surname

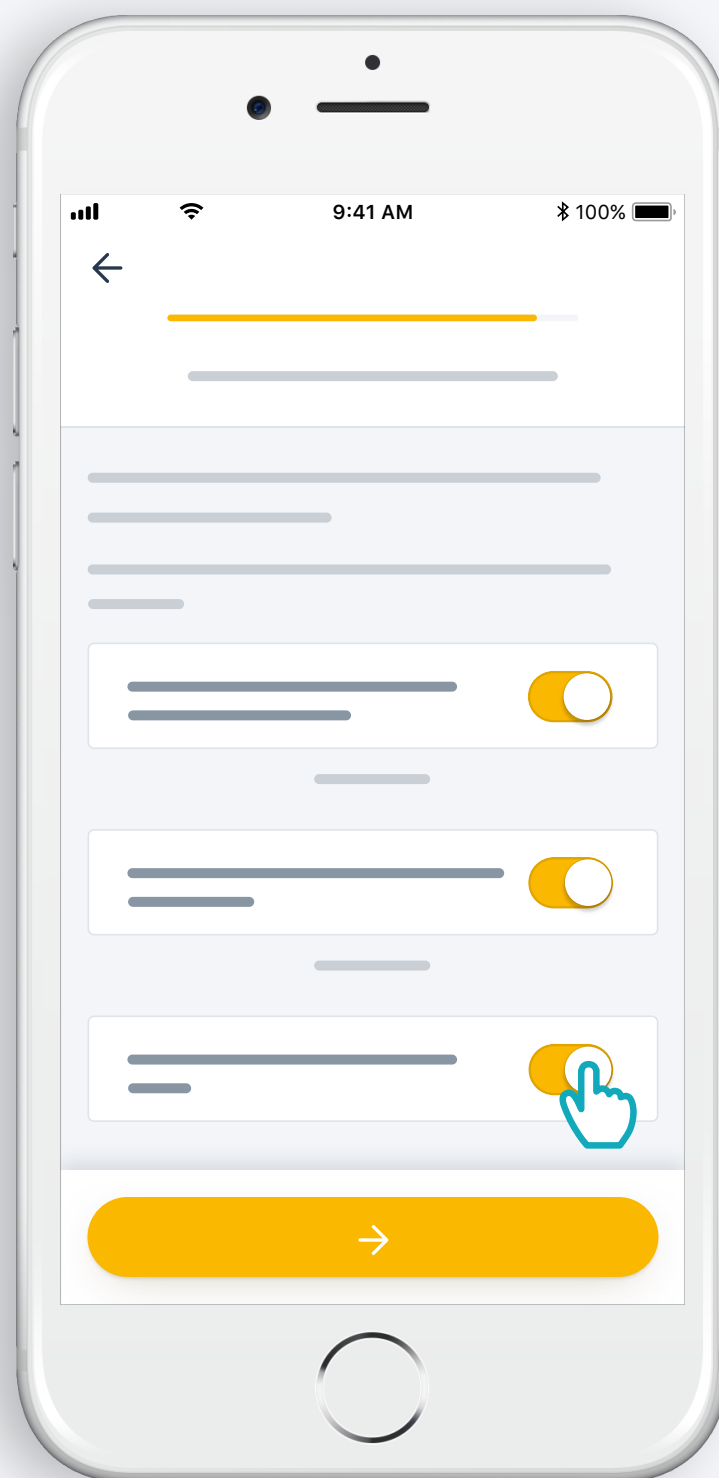

Accept Terms and
Conditions

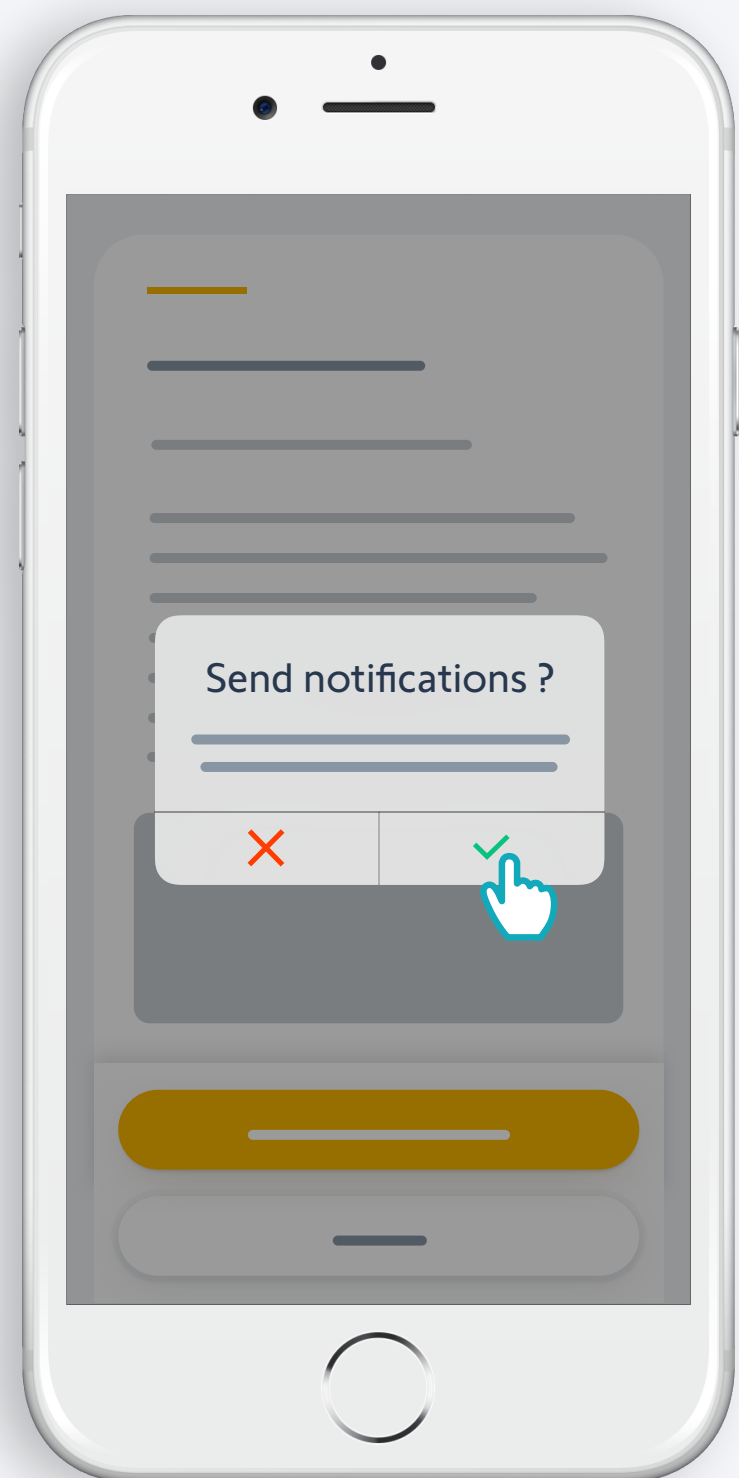

Authorize
notifications for
better experience

Congratulations,
Connectivity kit is ready to use!

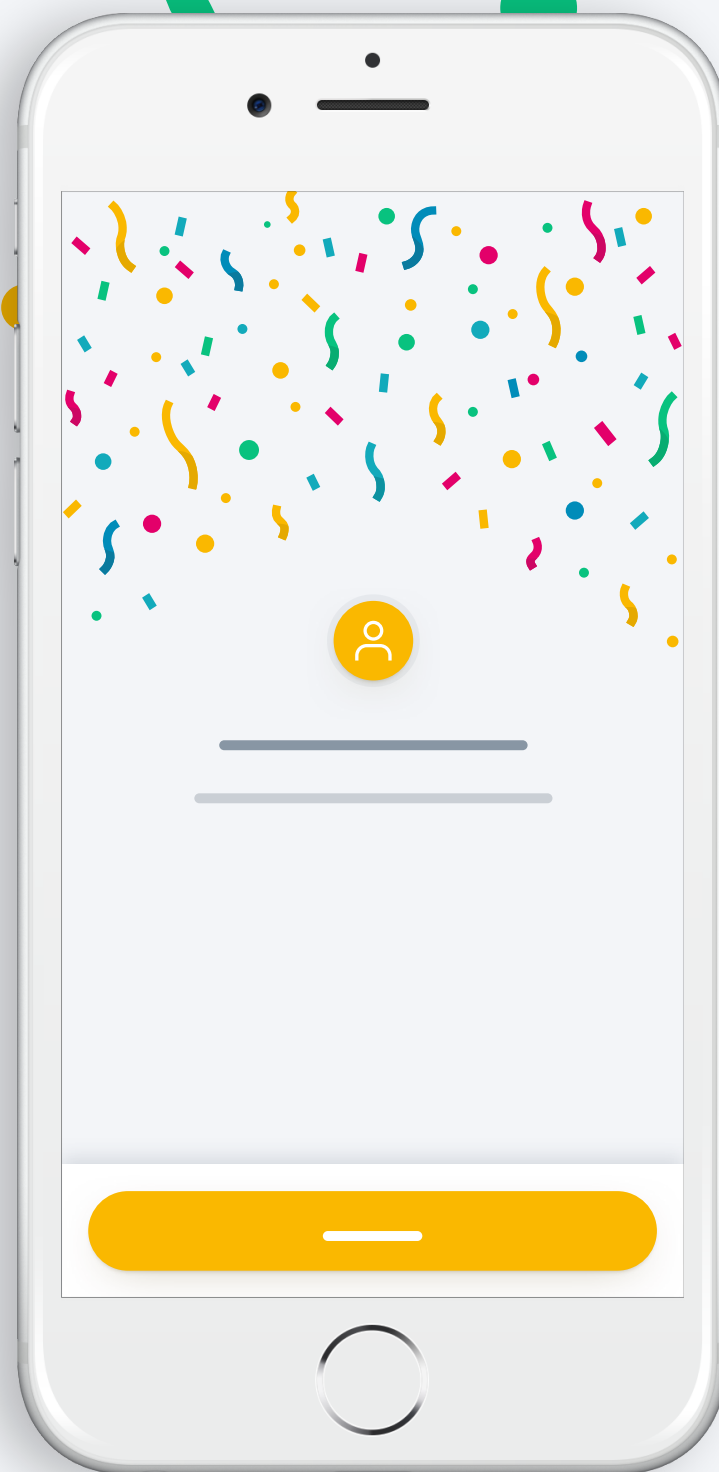

Now :

- Add products,
- easily control them from the app...
- ...or by voice when adding a voice assistant*,
- and discover all the possibilities offered by the app!

*: Requires an additional voice assistant (availability depending on countries)

somfy®